

Varenummer: 201581M625MTH1
 Beskrivelse: E+G Bolt GN 1582-M6-25-MT-H-1
 Hygiejnisk design

Mål

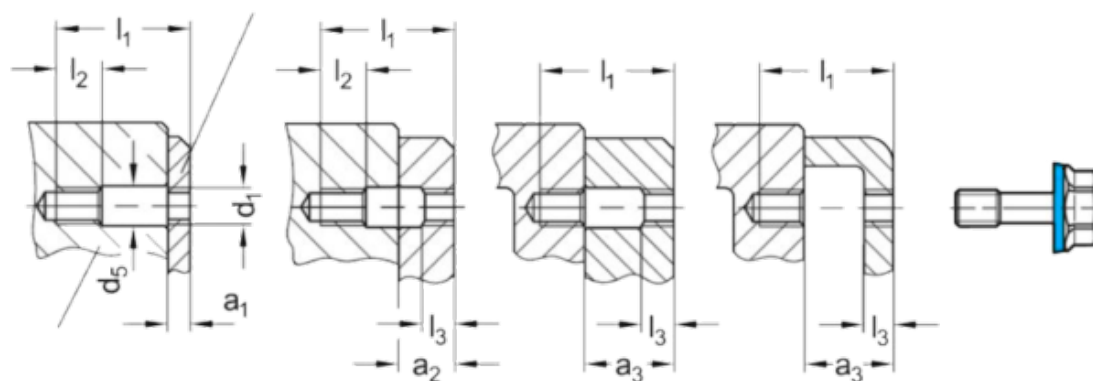
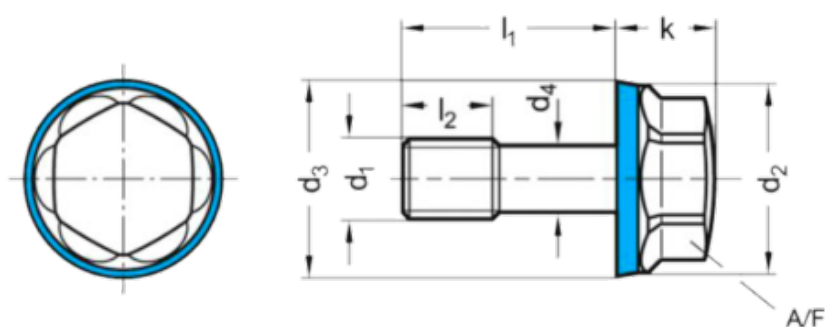

a1	= 3-7	l1	= 25
a2	= 7-13	l2	= 8
a3	= 13-17	l3	= 3
AF	= 10	Vægt	= 9
d3	= 13.8		
d4	-0,2 = -		
d5	= 6.5		
k	= 7.5		